

Edition 11

31251110000 Waschtischunterbau

PRODUKT

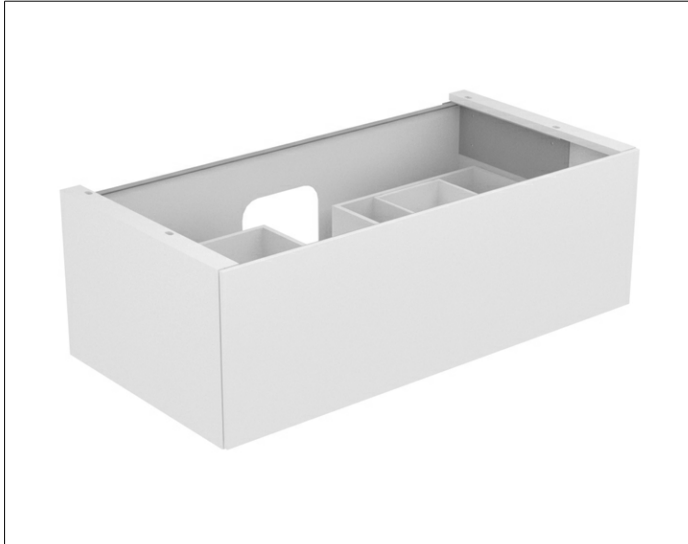

ZEICHNUNG

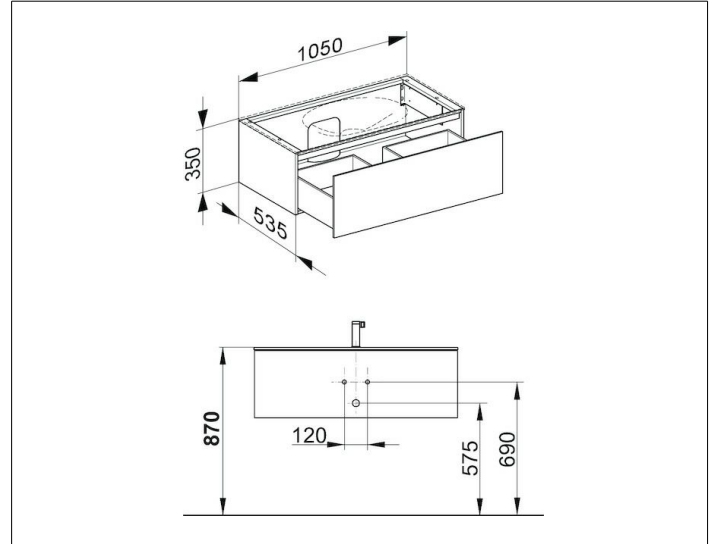

OBERFLÄCHE

anthrazit/Glas anthrazit

ABMESSUNG

1050 x 350 x 535 mm