

Edition 400

31574450100 Waschtischunterbau

PRODUKT



ZEICHNUNG

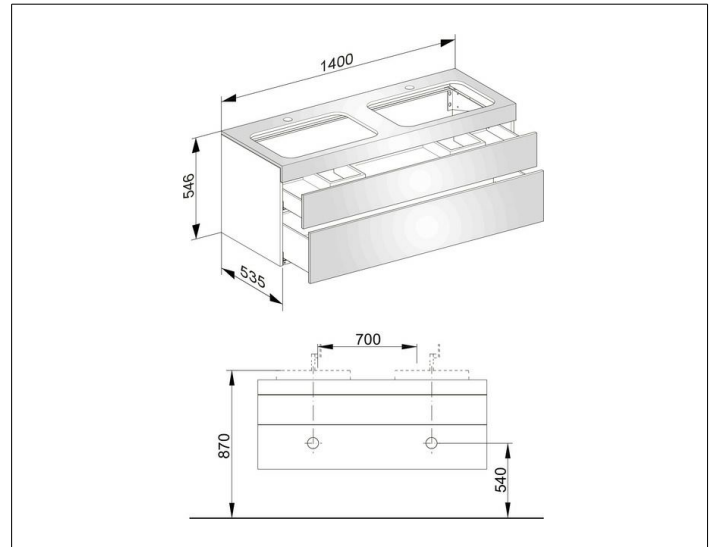

OBERFLÄCHE

cashmere/cashmere

ABMESSUNG

1400 x 546 x 535 mm