

- Ⓓ **Montageanleitung**
- ⒼⒷ **Installation instructions**
- Ⓕ **Montage**
- ⒼⓁ **Montage van**
- Ⓘ **Istruzioni di montaggio**
- Ⓔ **Montaje instrucciones**
- ⒴ **Instrukcja montażu**

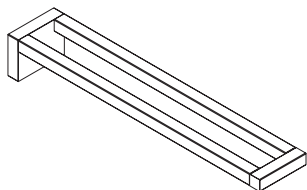

100.09.10040/100.09.10060

Handtuchhalter
Towel rail
Porte-serviettes
Handdoekhouder
Portasciugamani
Toallero
Uchwyt na ręcznik

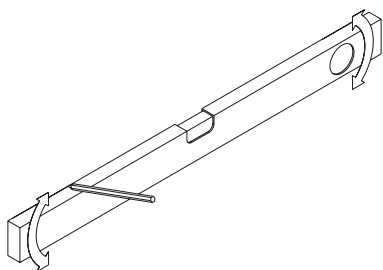

1

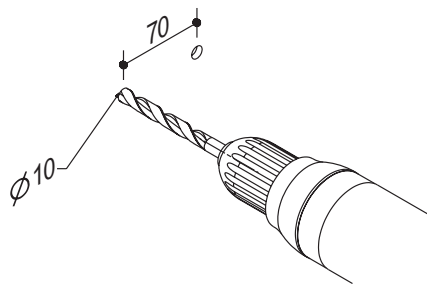

2

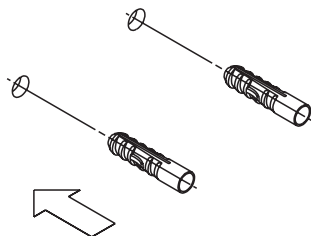

3

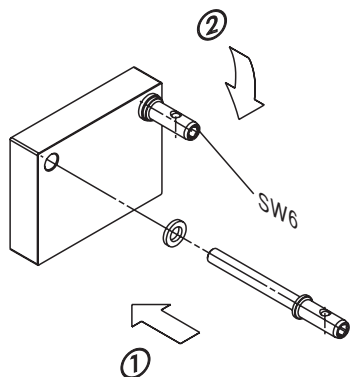

4

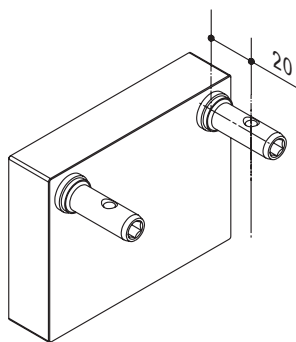

5

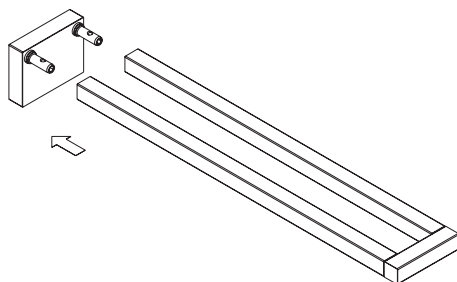

6

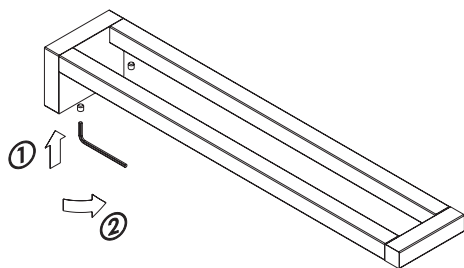

7

HEWI

www.hewi.com

Deutschland

HEWI Heinrich Wilke GmbH

Postfach 1260

D-34442 Bad Arolsen

Telefon: +49 5691 82-0

Telefax: +49 5691 82-319

info@hewi.de

www.hewi.de