

Edition 11

31315110000 Modul Unterbauschrank

PRODUKT

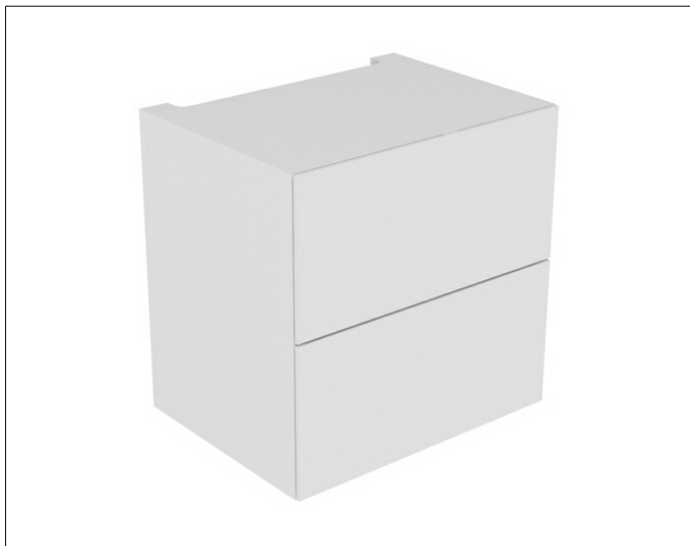

ZEICHNUNG

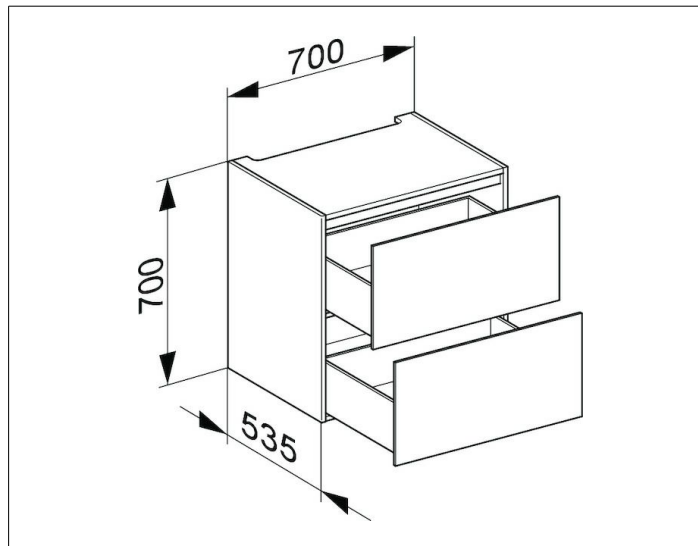

OBERFLÄCHE

anthrazit/Glas anthrazit

ABMESSUNG

700 x 700 x 535 mm