

Edition 400

31582110000 Waschtischunterbau

PRODUKT



ZEICHNUNG

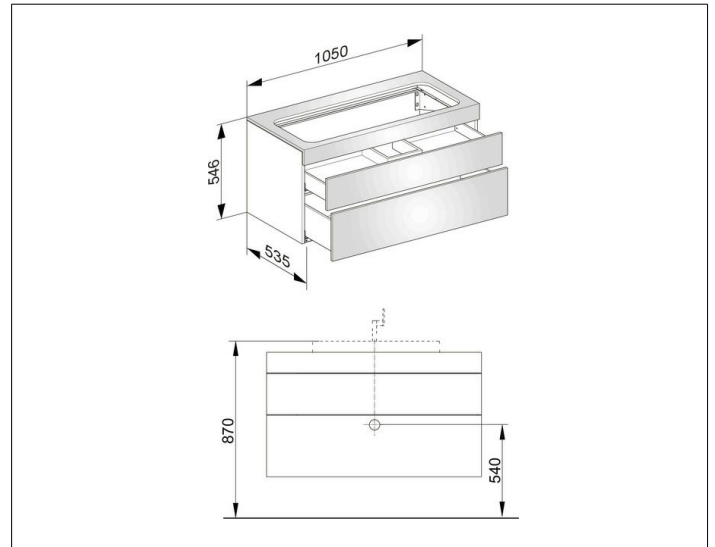

OBERFLÄCHE

anthrazit/Glas anthrazit klar

ABMESSUNG

1050 x 546 x 535 mm