

DE Gebrauchsanleitung / Montageanleitung

2

EN Instructions for use / Assembly instructions

2

TR Kullanım kılavuzu / Montaj kılavuzu

3

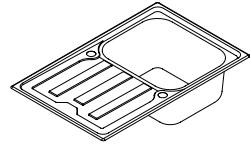

S440-A342 79

43364800

S440-A342 86

43365800

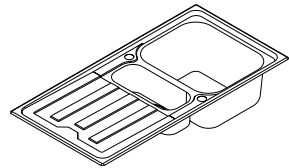

S440-A517 100

43366800

S440-F517 100

43370800

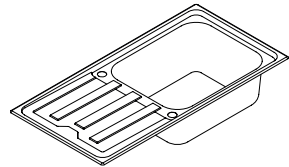

S440-A500 100

43367800

S440-F500 100

43371800

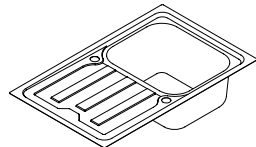

S440-F342 79

43368800

S440-F342 86

43369800



Sicherheitshinweise

⚠ Bei der Montage müssen zur Vermeidung von Quetsch- und Schnittverletzungen Handschuhe getragen werden.

Montagehinweise

- Vor der Montage muss das Produkt auf Transportschäden untersucht werden. Nach dem Einbau werden keine Transport- oder Oberflächenschäden anerkannt.
- Die in den Ländern jeweils gültigen Installationsrichtlinien sind einzuhalten.
- Beim Einbau der Unterbauspülen in Arbeitsplatten aus Natur- oder Kunststein, Keramik oder Glas müssen die mitgelieferten Dübel mit geeignetem Kleber fixiert werden.

Symbolerklärung



Kein essigsäurehaltiges Silikon verwenden!



Maße (siehe Seite 7)



Serviceteile (siehe Seite 8)



Reinigung (siehe Seite 8)

Safety Notes

⚠ Gloves should be worn during installation to prevent crushing and cutting injuries.

Installation Instructions

- Prior to installation, inspect the product for transport damages. After it has been installed, no transport or surface damage will be honoured.
- The plumbing codes applicable in the respective countries must be observed.
- For installation of the underbuild unit sink in counter-tops made of natural or artificial stone, ceramics or glass, the dowels comprised in the delivery must be glued in with a suitable adhesive.

Symbol description



Do not use silicone containing acetic acid!



Dimensions (see page 7)



Spare parts (see page 8)



Cleaning (see page 8)



Aufliegende Montage

(siehe Seite 4)



Surface-mounted installation

(see page 4)



Bündige Montage

(siehe Seite 6)



Flush installation

(see page 6)



Güvenlik uyarıları

⚠ Montaj esnasında ezilme ve kesilme gibi yaralanmaları önlemek için eldiven kullanılmalıdır.

Montaj açıklamaları

- Montaj işleminden önce ürün nakliye hasarları yönünden kontrol edilmelidir. Montaj işleminden sonra nakliye veya yüzey hasarları için sorumluluk üstlenilmemektedir.
- Ülkelerde geçerli kurulum yönetmeliklerine riayet edilmelidir.
- Gömme evyeleri, doğal veya yapay taştan, seramik veya cam çalışma tezgahlarına monte ederken birlikte teslim edilen dübeller uygun bir yapıştırıcıyla sabitlenmelidir.

Simge açıklaması



Asetik asit içeren silikon kullanmayın!



Ölçüleri (bakınız sayfa 7)



Yedek Parçalar (bakınız sayfa 8)



Temizleme (bakınız sayfa 8)

Garanti Belgesi

Üretici veya İthalatçı Firmasının

Unvanı: Hansgrohe Armatür Ltd. Şti
Adresi: Fulya Mahallesi Bahçeler Sokak Efe han 20/C
Mecidiyeköy Şişli İstanbul
Telefonu: (0-212) 273 07 30
Faks: (0-212) 273 07 40
web adresi: www.hansgrohe.com.tr

Malın

Markası: Hansgrohe
Cinsi: Sıhhi tesisat malzemesi
Garanti Süresi: 2 YIL
Azami Tamir Süresi: 20 İş günü

Genel Müdür

Albert Emlek

Satıcı Firmasının:

Unvanı:

Adresi:

Telefonu:

Faks:

e-posta:

Fatura Tarih ve Sayısı:

Marka ve Modeli:

Teslim Tarihi ve Yeri:

Yetkilinin İmzası:

Firmanın Kaşesi:

Bu bölümü, ürünü aldığınız Yetkili Satıcı imzalayacak ve kaşeleyecektir.



Tezgah üzerinde montaj
(bakınız sayfa 4)



Tezgaha sıfır montaj
(bakınız sayfa 6)

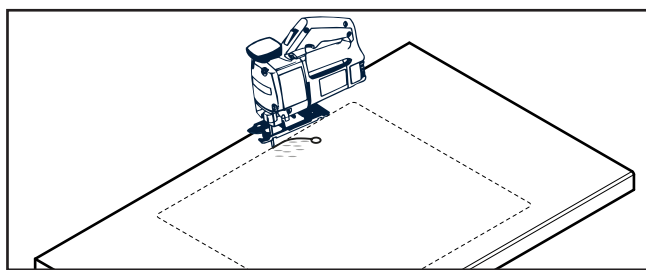
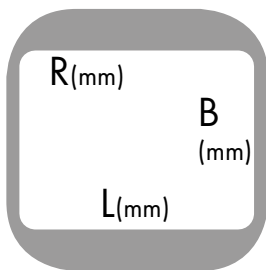
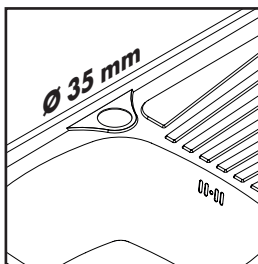
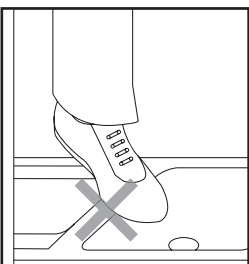
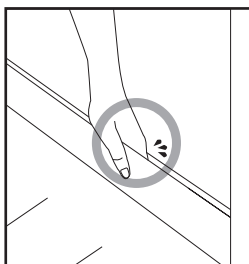
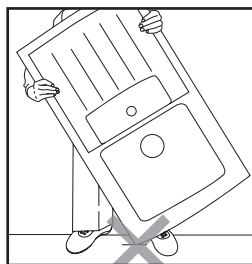

		L	B	R
43364800		770	480	20
43365800		840	480	20
43366800		980	480	20
43367800		980	480	20
43368800		800	490	20
43369800		850	490	20
43370800		990	490	20
43371800		990	490	20

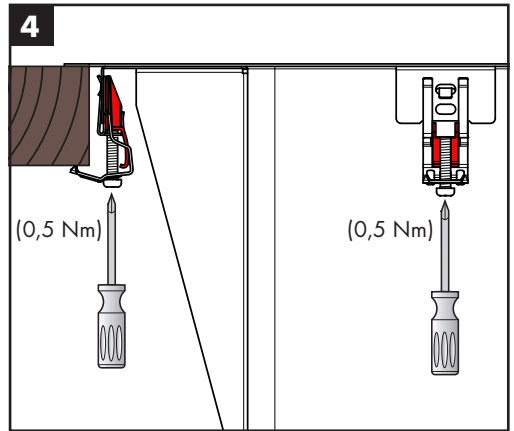
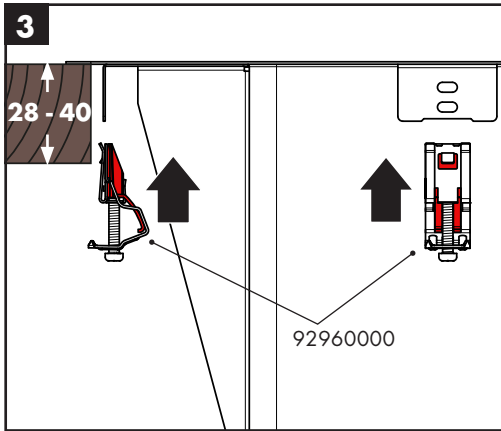
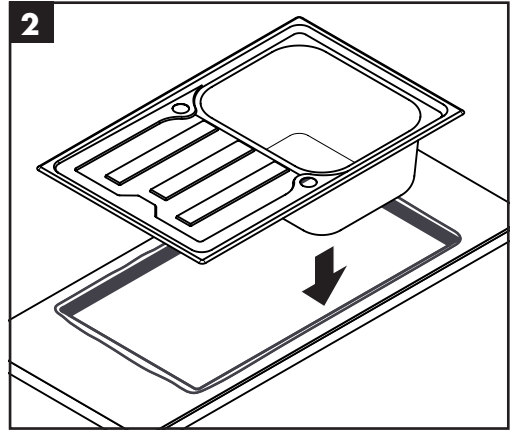
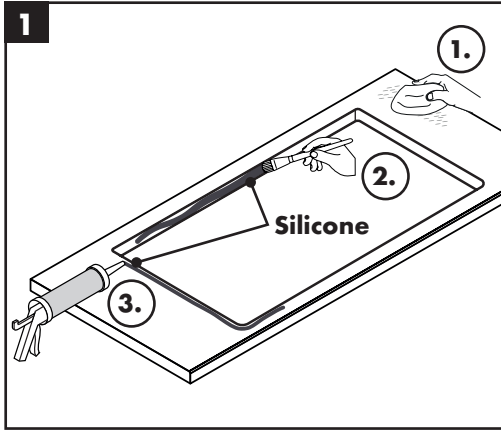

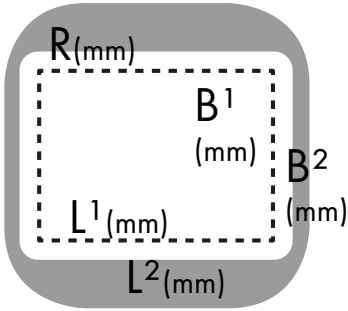

		L ¹	L ²	B ¹	B ²	R
43368800		800	822	490	512	7
43369800		850	872	490	512	7
43370800		990	1012	490	512	7
43371800		990	1012	490	512	7

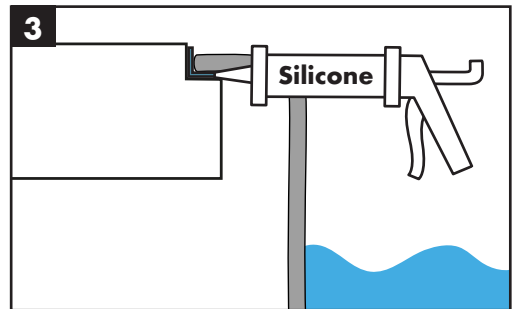
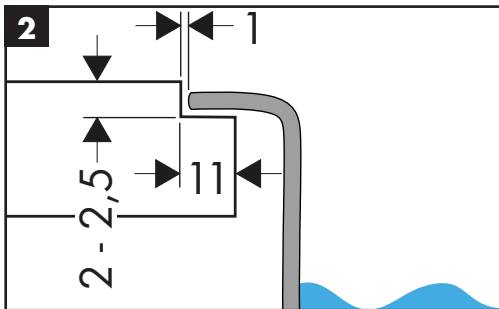
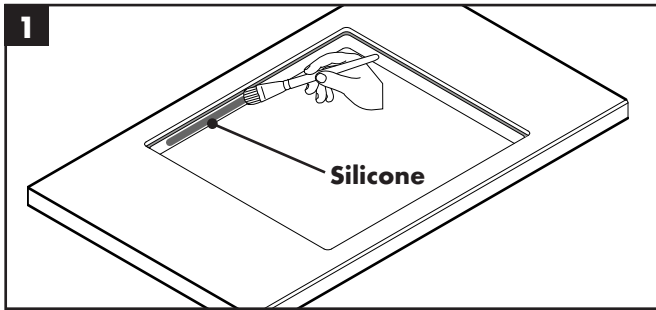



S440-A342 79

43364800

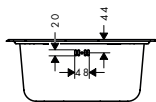
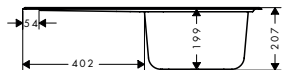
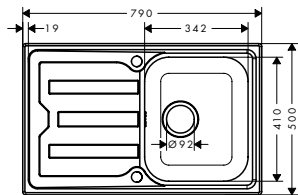

S440-A342 86

43365800

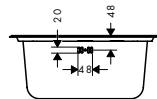
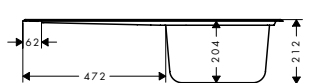
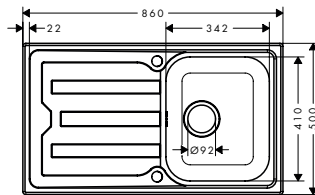

S440-A517 100

43366800

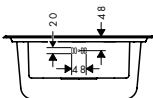
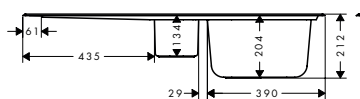
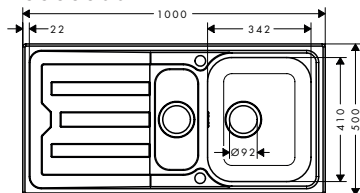

S440-A500 100

43367800

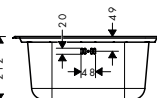
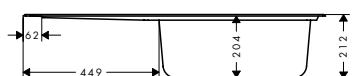
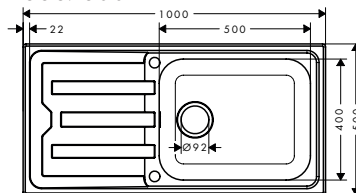

S440-F342 79

43368800

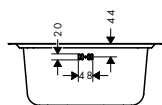
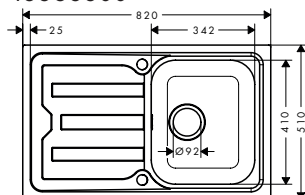

S440-F342 86

43369800

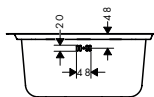
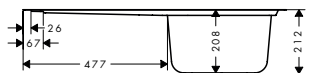
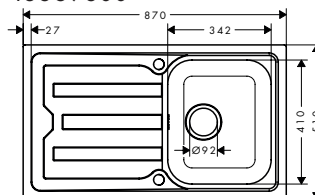



S440-F517 100

43370800

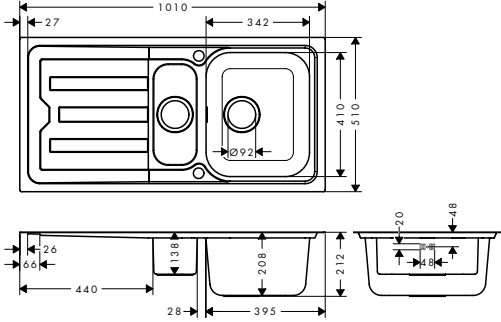

S440-F500 100

43371800

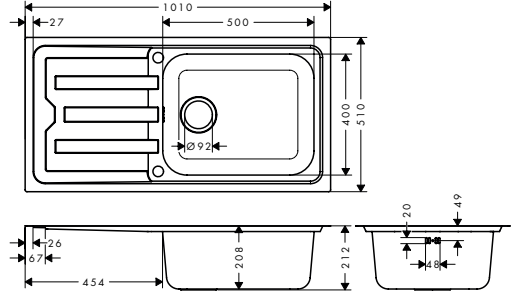

www.hansgrohe.com/cleaning-recommendation

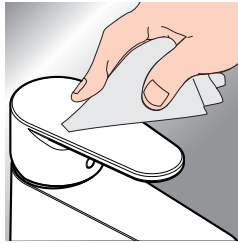

DE Reinigungsempfehlung / Garantie / Kontakt
EN Cleaning recommendation / Warranty / Contact

TR Temizleme önerisi / Garanti / Temas

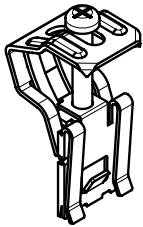

92960000

28 - 40 mm