

Explosionszeichnung

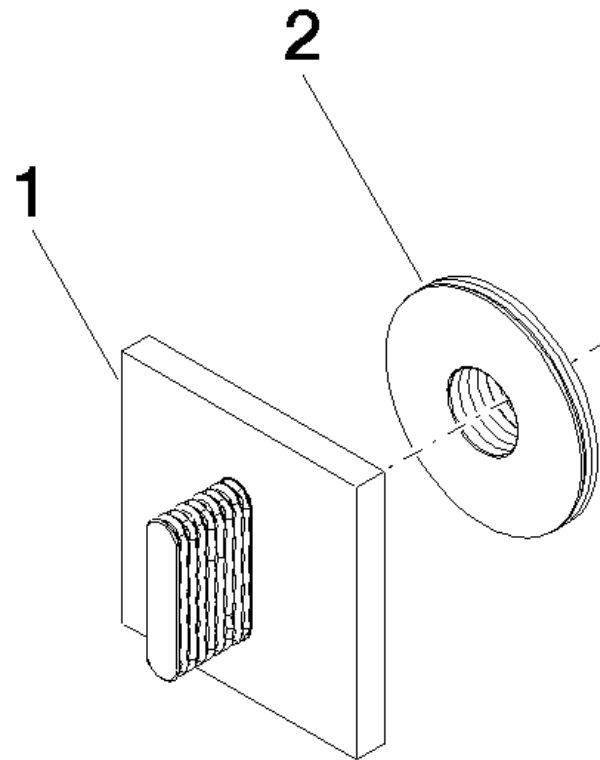

Artikelnummer: 36102705



Bestellmenge

Nr.	Artikelnummer	Benennung	Verbaumenge
1	90207005300ff	Griff	1
2	09210210990	Abdeckung	1