

Edition 400

31571110000 Waschtischunterbau

PRODUKT



ZEICHNUNG

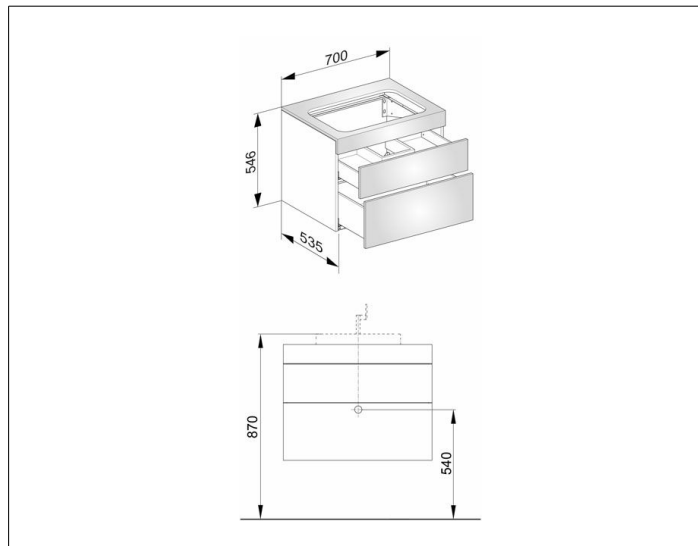

OBERFLÄCHE

anthrazit/Glas anthrazit klar

ABMESSUNG

700 x 546 x 535 mm