

Edition 400

31541380000 Waschtischunterbau

PRODUKT



ZEICHNUNG

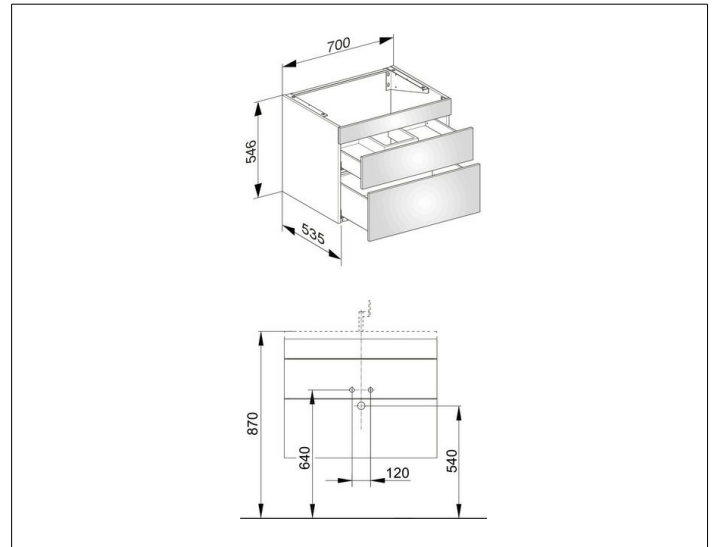

OBERFLÄCHE

weiß/weiß

ABMESSUNG

700 x 546 x 535 mm