

Explosionszeichnung

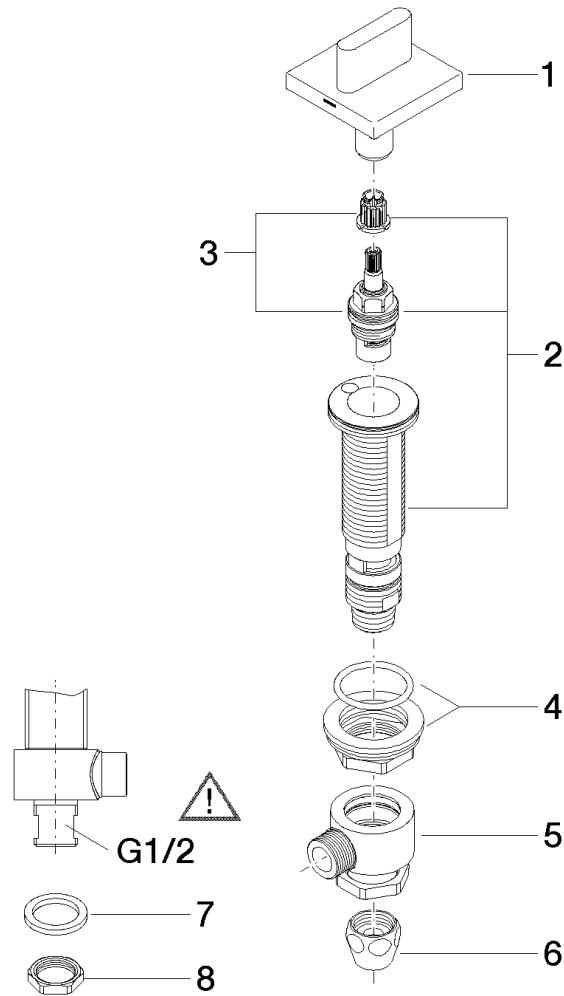

Bestellmenge

Nr.	Artikelnummer	Benennung	Verbaumenge
1	90207005105ff	Griff	1
2	0417110453290	Seitenteil	1
3	9090031320090	Oberteil	1
4	0423100327890	Befestigungssatz	1
5	0417110231090	Verteiler	1
6	04233004000ff	Verschraubung	1
7	09301105990	Scheibe	1
8	09231001290	Mutter	1

Durchflussdiagramm

