

INSTALLATION MANUAL

MONTAGEANLEITUNG
INSTRUCTIONS DE MONTAGE
ISTRUZIONI PER IL MONTAGGIO

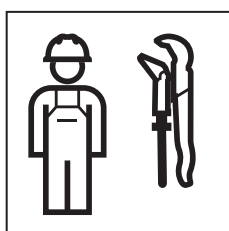

966.726.00.0(01)



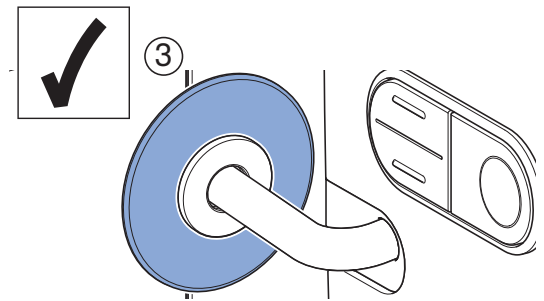
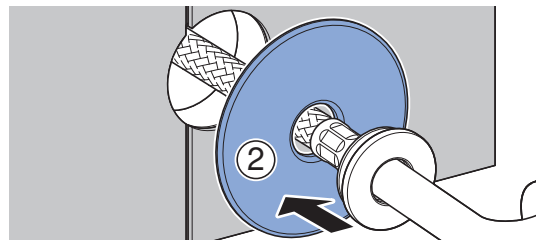
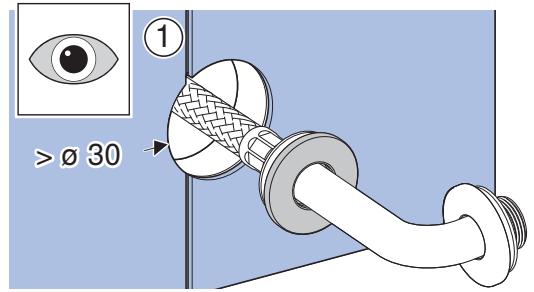
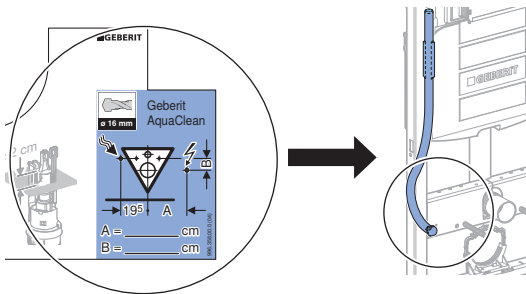



1

1

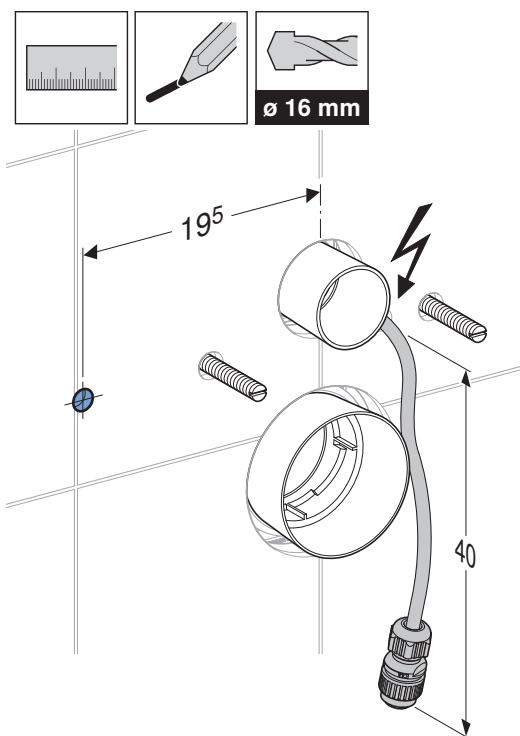

2

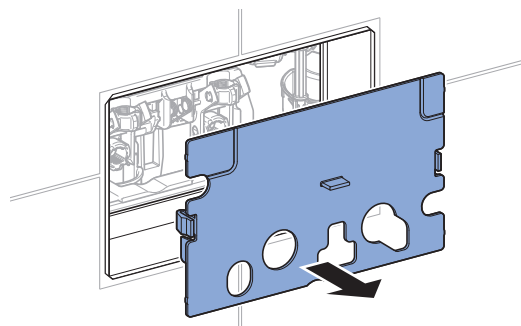

3

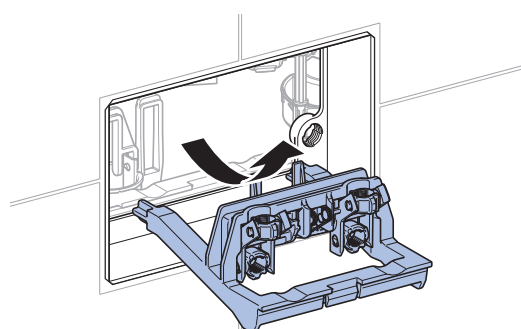

4

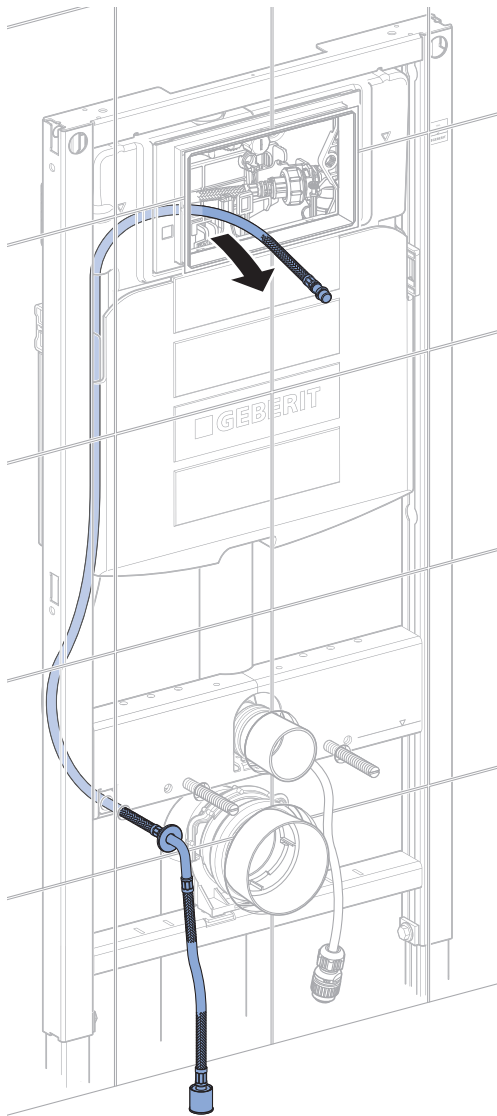
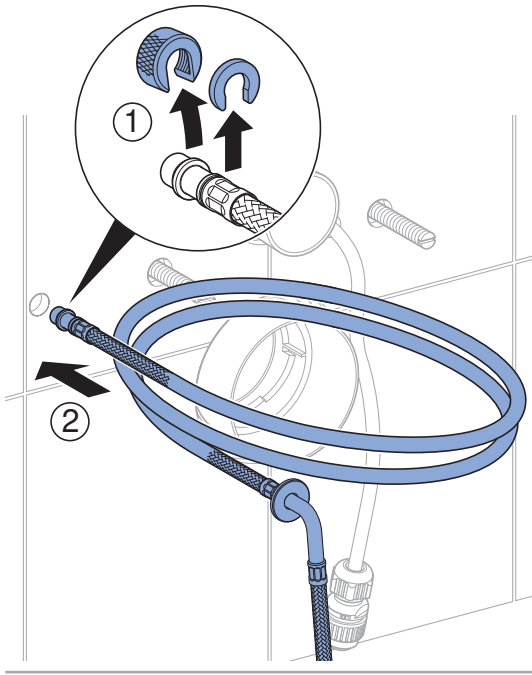

2

1

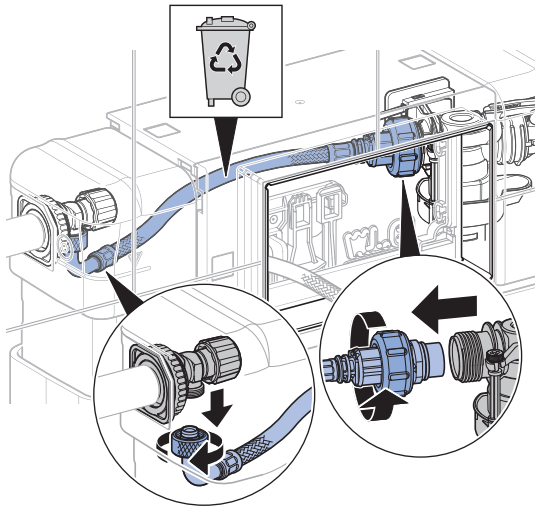

2

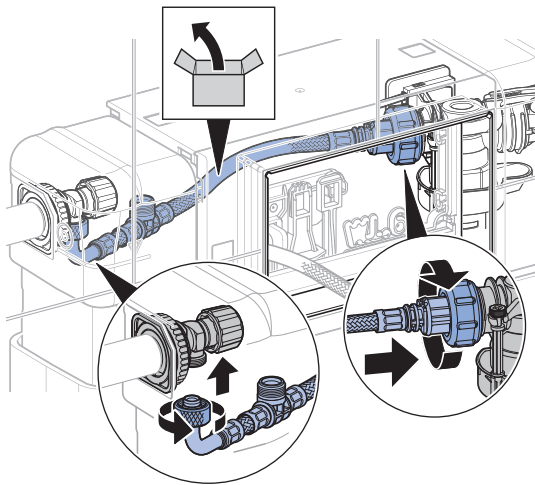

3

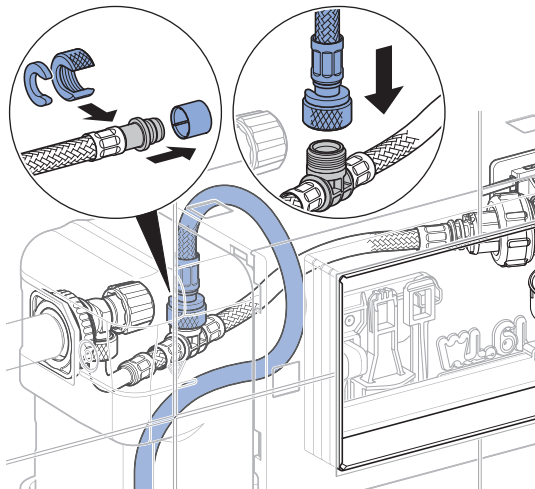

3



Installation Manual

966.729

1

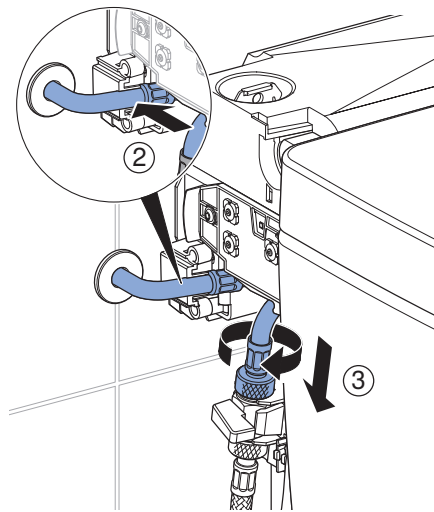
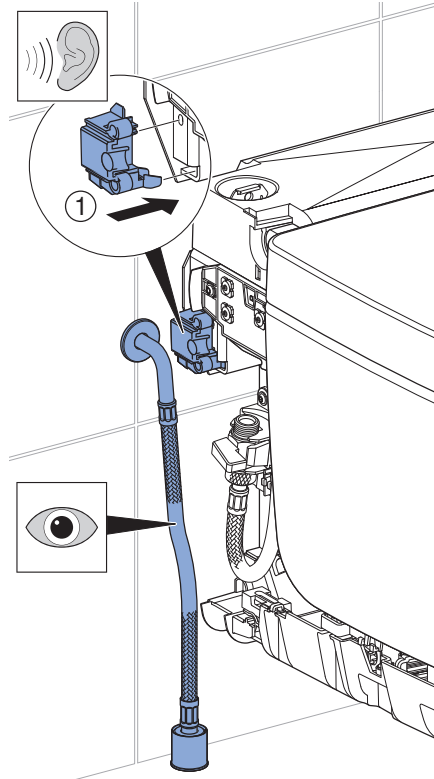

2

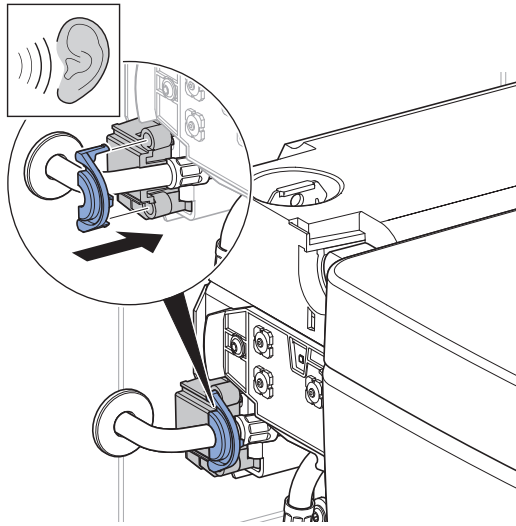

3

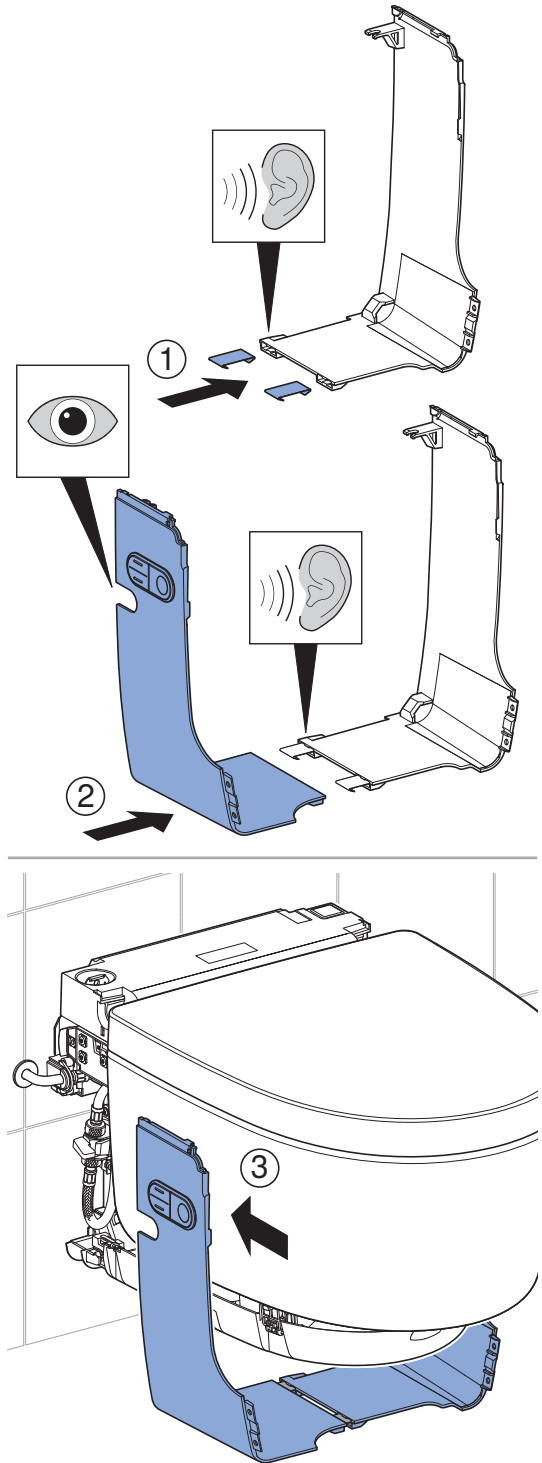

Geberit International AG
Schachenstrasse 77, CH-8645 Jona
documentation@geberit.com
www.geberit.com

