

Edition 400

31571150000 Waschtischunterbau

PRODUKT



ZEICHNUNG

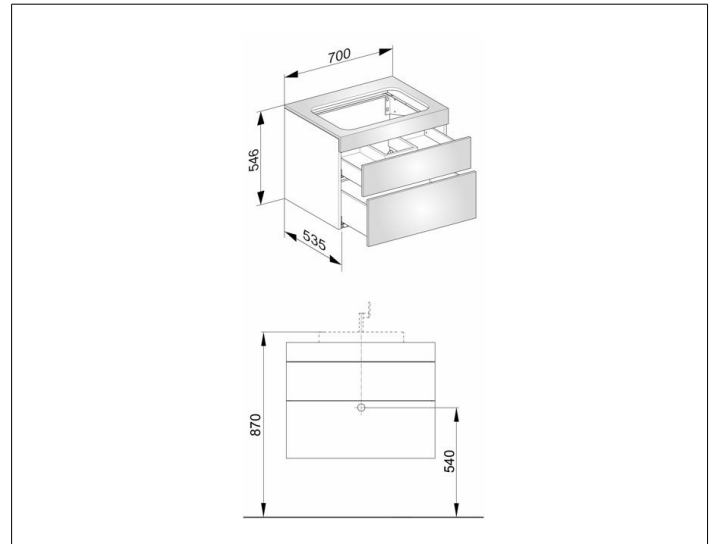

OBERFLÄCHE

anthrazit/Glas anthrazit satiniert

ABMESSUNG

700 x 546 x 535 mm