

Edition 400

31583380000 Waschtischunterbau

PRODUKT



ZEICHNUNG

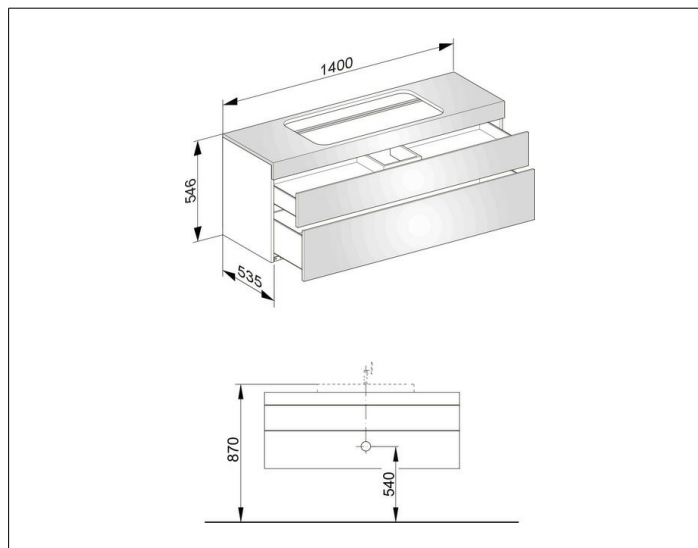

OBERFLÄCHE

weiß/weiß

ABMESSUNG

1400 x 546 x 535 mm