







13 805 811



- Ausladung 190 mm
- starrer Auslauf
- rechteckiger luftangereicherter Strahl
- Bohrungsdurchmesser 37 mm
- Anschluss 1/2"
- Durchfluss max. 4,5 l/min
- bleifrei
- Dieses Produkt leistet einen Beitrag zur Erfüllung der Vorgaben von nachhaltigen Gebäudezertifizierungen, z.B. LEED®, BREEAM®, DGNB

	Chrom	13 805 811-00
	Platin gebürstet	13 805 811-06
	Dark Chrome	13 805 811-19
	Messing gebürstet (23kt Gold)	13 805 811-28
	Platin / Platin gebürstet	13 805 811-36
	Messing / Messing gebürstet (23kt Gold)	13 805 811-38
	Dark Platin gebürstet	13 805 811-99

Empfohlenes Zubehör



UP-Wandwinkel -

35 085 970 90

- Max. Einbautiefe 163 mm
- Min. Einbautiefe 90 mm

13 805 811

mm [inches]

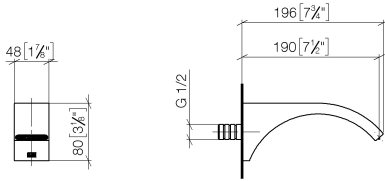

Durchflussdiagramm

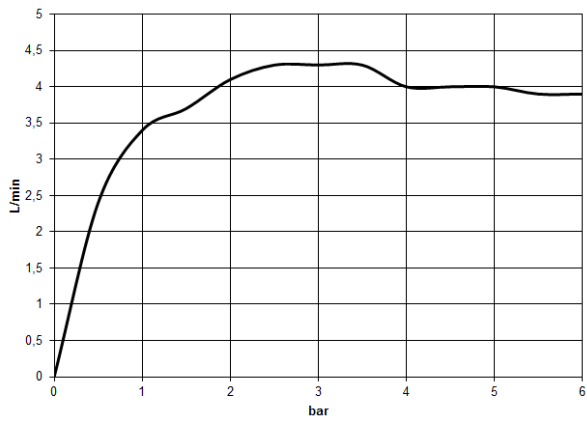

Codes & Standards

ASME A112.18.1	cUPC	DIN 4109	EPA WaterSense
ISO 3822	NSF372	NSF61	Ü-Zeichen

WaterSense





CYO Waschtisch-Wand-Auslauf ohne Ablaufgarnitur - Chrom

CYO

13 805 811

Zertifikate

IAPMO_8834

IAPMO_N-4

IAPMO_6

LGA_38

IAPMO_4976

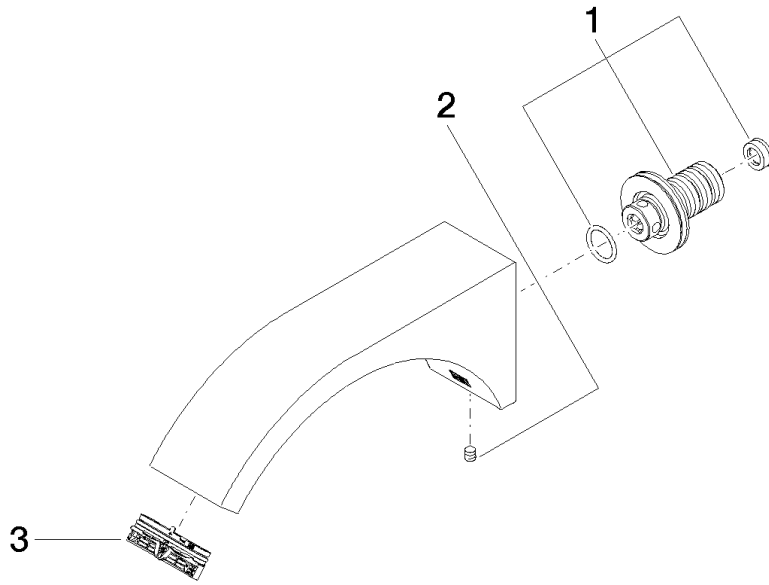



CYO Waschtisch-Wand-Auslauf ohne Ablaufgarnitur - Chrom

CYO

13 805 811

Ersatzteilstückliste

Nr.	Artikelnummer	Benennung	Verbaumenge	Lieferzeit
	90 24 03 108 01 90	Nippel Ø 40 x 50 mm, 4,54 l/min. -	3	2