

SCHRANK SUBWAY 3.0









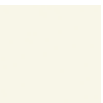

PRODUKTINFORMATION

1. POSITION



| | |
|--------------------|---|
| Modell | C57700 |
| Kollektion | Subway 3.0 |
| PROJECTS | DESIGN |
| Breite | 572 mm |
| Höhe | 429 mm |
| Tiefe | 478 mm |
| Beschreibung | Holz Befestigungsset wird mitgeliefert Waschbecken mittig Griffe: Griff Aluminium glänzend Ausstattung: 1x Auszug mit Antirutsch- Boden, 1x Accessory Schale (klein) Kombinierbar mit: Subway 3.0 4A70 60/61/63 Definierte Waschbecken bitte separat bestellen, Dem Stornierungs- oder Änderungswunsch kann nicht in jedem Fall entsprechen werden. |
| Montage | wandhängend |
| Material | Holz |
| Ausschreibungstext | Subway 3.0; Waschbeckenunterschrank; Holz; Maße: 572 x 429 x 478 mm; Eckig; wandhängend; Befestigungsset wird mitgeliefert; Waschbecken mittig; Ausstattung: 1x Auszug mit Antirutsch- Boden, 1x Accessory Schale (klein); Kombinierbar mit: Subway 3.0 4A70 60/61/63; Definierte Waschbecken bitte separat bestellen, Dem Stornierungs- oder Änderungswunsch kann nicht in jedem Fall entsprechen werden.; Griffe: Griff Aluminium glänzend |

FARBEN

| VORSCHAU | FARBNAME | FARBCODE | ARTIKELNUMMER | PREIS |
|--|-----------------|----------|---------------|-------|
|  | Kansas Oak | C57700RH | 4062373840573 | |
|  | Stone Oak | C57700RK | 4062373840580 | |
|  | Brilliant White | C57700VE | 4062373840528 | |
|  | Pure White | C57700VF | 4062373840535 | |
|  | Cashmere Grey | C57700VN | 4062373840603 | |
|  | Marine Blue | C57700VQ | 4062373840610 | |
|  | Graphite | C57700VR | 4062373840627 | |
|  | Arizona Oak | C57700VH | 4062373840559 | |
|  | Nordic Oak | C57700VJ | 4062373840566 | |
|  | Volcano Black | C57700VL | 4062373840542 | |
|  | Taupe | C57700VM | 4062373840597 | |

TECHNISCHE ZEICHNUNGEN

C57700

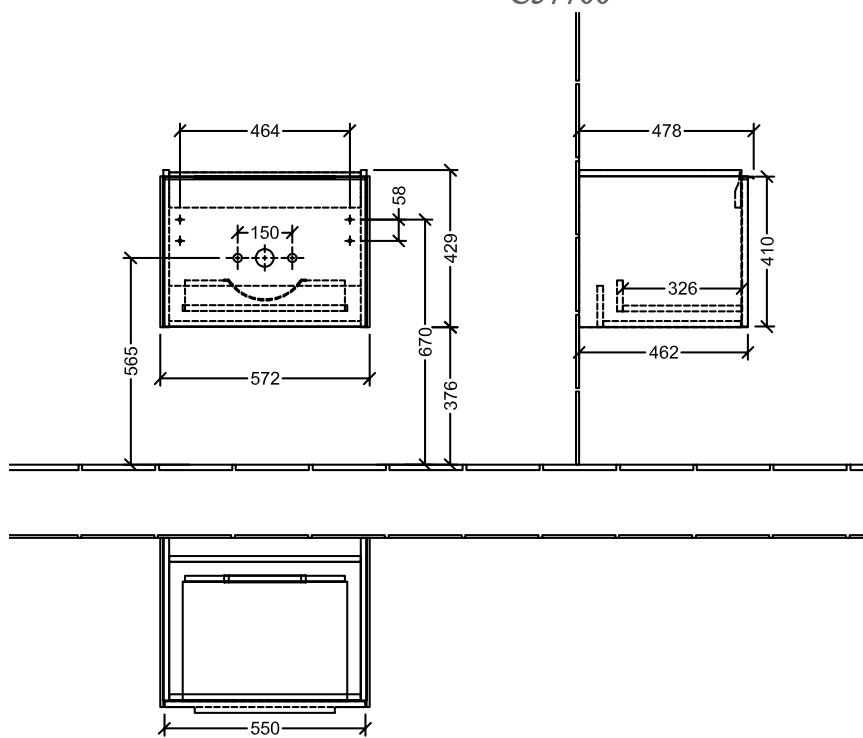

| | |
|---------------------|---|
| Subway 3.0 C5770 |  Villeroy & Boch 1748 |
| V01 / 08.12.2020 | |